

MMBZ5221BLT1 Series

Zener Voltage Regulators

225 mW SOT-23 Surface Mount

This series of Zener diodes is offered in the convenient, surface mount plastic SOT-23 package. These devices are designed to provide voltage regulation with minimum space requirement. They are well suited for applications such as cellular phones, hand held portables, and high density PC boards.

Specification Features:

- 225 mW Rating on FR-4 or FR-5 Board
- Zener Voltage Range – 2.4 V to 91 V
- Package Designed for Optimal Automated Board Assembly
- Small Package Size for High Density Applications
- ESD Rating of Class 3 (>16 KV) per Human Body Model

Mechanical Characteristics:

CASE: Void-free, transfer-molded, thermosetting plastic case

FINISH: Corrosion resistant finish, easily solderable

MAXIMUM CASE TEMPERATURE FOR SOLDERING PURPOSES:

260°C for 10 Seconds

POLARITY: Cathode indicated by polarity band

FLAMMABILITY RATING: UL94 V-0

MAXIMUM RATINGS

Rating	Symbol	Max	Unit
Total Power Dissipation on FR-5 Board, (Note 1) @ $T_A = 25^\circ\text{C}$ Derated above 25°C	P_D	225 1.8	mW mW/°C
Thermal Resistance – Junction-to-Ambient	$R_{\theta JA}$	556	°C/W
Total Power Dissipation on Alumina Substrate, (Note 2) @ $T_A = 25^\circ\text{C}$ Derated above 25°C	P_D	300 2.4	mW mW/°C
Thermal Resistance – Junction-to-Ambient	$R_{\theta JA}$	417	°C/W
Junction and Storage Temperature Range	T_J, T_{stg}	-65 to +150	°C

1. FR-5 = 1.0 X 0.75 X 0.62 in.

2. Alumina = 0.4 X 0.3 X 0.024 in., 99.5% alumina



ON Semiconductor®

<http://onsemi.com>

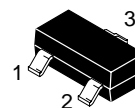
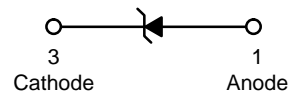

SOT-23
CASE 318
STYLE 8

MARKING DIAGRAM

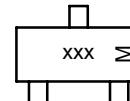

xxx = Specific Device Code
M = Date Code

ORDERING INFORMATION

Device †	Package	Shipping
MMBZ52xxBLT1	SOT-23	3000/Tape & Reel
MMBZ52xxBLT3*	SOT-23	10,000/Tape & Reel

*MMBZ5233BLT1, MMBZ5246BLT1, MMBZ5251BLT1, and MMBZ5252BLT1 Not Available in 10,000/Tape & Reel.

DEVICE MARKING INFORMATION

See specific marking information in the device marking column of the Electrical Characteristics table on page 3 of this data sheet.

Devices listed in **bold, italic** are ON Semiconductor **Preferred** devices. **Preferred** devices are recommended choices for future use and best overall value.

†The "T1" suffix refers to an 8 mm, 7 inch reel.
The "T3" suffix refers to an 8 mm, 13 inch reel.

MMBZ5221BLT1 Series

ELECTRICAL CHARACTERISTICS

(Pinout: 1-Anode, 2-No Connection, 3-Cathode) ($T_A = 25^\circ\text{C}$ unless otherwise noted, $V_F = 0.95\text{ V Max. @ } I_F = 10\text{ mA}$)

Symbol	Parameter
V_Z	Reverse Zener Voltage @ I_{ZT}
I_{ZT}	Reverse Current
Z_{ZT}	Maximum Zener Impedance @ I_{ZT}
I_{ZK}	Reverse Current
Z_{ZK}	Maximum Zener Impedance @ I_{ZK}
I_R	Reverse Leakage Current @ V_R
V_R	Reverse Voltage
I_F	Forward Current
V_F	Forward Voltage @ I_F

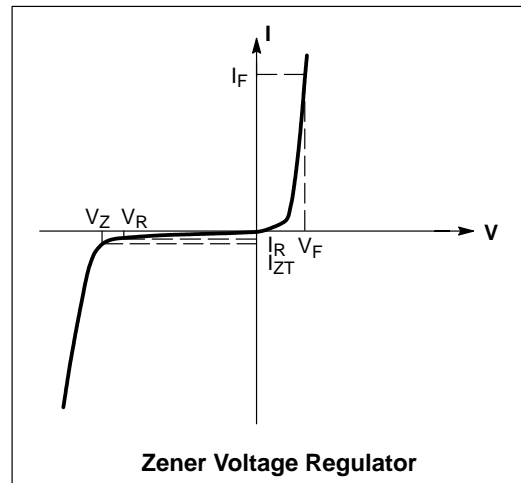

MMBZ5221BLT1 Series

ELECTRICAL CHARACTERISTICS (Pinout: 1-Anode, 2-NC, 3-Cathode) ($V_F = 0.9\text{ V Max @ }I_F = 10\text{ mA}$ for all types.)

Device	Device Marking	Zener Voltage (Note 3)				Zener Impedance			Leakage Current	
		V_Z (Volts)			@ I_{ZT}	Z_{ZT} @ I_{ZT}	Z_{ZK} @ I_{ZK}		I_R @ V_R	
		Min	Nom	Max	mA	Ω	Ω	mA	μA	Volts
MMBZ5221BLT1	18A	2.28	2.4	2.52	20	30	1200	0.25	100	1
MMBZ5222BLT1	18B	2.37	2.5	2.63	20	30	1250	0.25	100	1
MMBZ5223BLT1	18C	2.56	2.7	2.84	20	30	1300	0.25	75	1
MMBZ5224BLT1	18D	2.66	2.8	2.94	20	30	1400	0.25	75	1
MMBZ5225BLT1	18E	2.85	3	3.15	20	29	1600	0.25	50	1
MMBZ5226BLT1	8A	3.13	3.3	3.47	20	28	1600	0.25	25	1
MMBZ5227BLT1	8B	3.42	3.6	3.78	20	24	1700	0.25	15	1
MMBZ5228BLT1	8C	3.70	3.9	4.10	20	23	1900	0.25	10	1
MMBZ5229BLT1	8D	4.08	4.3	4.52	20	22	2000	0.25	5	1
MMBZ5230BLT1	8E	4.46	4.7	4.94	20	19	1900	0.25	5	2
MMBZ5231BLT1	8F	4.84	5.1	5.36	20	17	1600	0.25	5	2
MMBZ5232BLT1	8G	5.32	5.6	5.88	20	11	1600	0.25	5	3
MMBZ5233BLT1*	8H	5.70	6	6.30	20	7	1600	0.25	5	3.5
MMBZ5234BLT1	8J	5.89	6.2	6.51	20	7	1000	0.25	5	4
MMBZ5235BLT1	8K	6.46	6.8	7.14	20	5	750	0.25	3	5
MMBZ5236BLT1	8L	7.12	7.5	7.88	20	6	500	0.25	3	6
MMBZ5237BLT1	8M	7.79	8.2	8.61	20	8	500	0.25	3	6.5
MMBZ5238BLT1	8N	8.26	8.7	9.14	20	8	600	0.25	3	6.5
MMBZ5239BLT1	8P	8.64	9.1	9.56	20	10	600	0.25	3	7
MMBZ5240BLT1	8Q	9.50	10	10.50	20	17	600	0.25	3	8
MMBZ5241BLT1	8R	10.4	11	11.55	20	22	600	0.25	2	8.4
MMBZ5242BLT1	8S	11.40	12	12.60	20	30	600	0.25	1	9.1
MMBZ5243BLT1	8T	12.35	13	13.65	9.5	13	600	0.25	0.5	9.9
MMBZ5244BLT1	8U	13.30	14	14.70	9	15	600	0.25	0.1	10
MMBZ5245BLT1	8V	14.25	15	15.75	8.5	16	600	0.25	0.1	11
MMBZ5246BLT1*	8W	15.20	16	16.80	7.8	17	600	0.25	0.1	12
MMBZ5247BLT1	8X	16.15	17	17.85	7.4	19	600	0.25	0.1	13
MMBZ5248BLT1	8Y	17.10	18	18.90	7	21	600	0.25	0.1	14
MMBZ5249BLT1	8Z	18.05	19	19.95	6.6	23	600	0.25	0.1	14
MMBZ5250BLT1	81A	19.00	20	21.00	6.2	25	600	0.25	0.1	15
MMBZ5251BLT1*	81B	20.90	22	23.10	5.6	29	600	0.25	0.1	17
MMBZ5252BLT1*	81C	22.80	24	25.20	5.2	33	600	0.25	0.1	18
MMBZ5253BLT1	81D	23.75	25	26.25	5	35	600	0.25	0.1	19
MMBZ5254BLT1	81E	25.65	27	28.35	4.6	41	600	0.25	0.1	21
MMBZ5255BLT1	81F	26.60	28	29.40	4.5	44	600	0.25	0.1	21
MMBZ5256BLT1	81G	28.50	30	31.50	4.2	49	600	0.25	0.1	23
MMBZ5257BLT1	81H	31.35	33	34.65	3.8	58	700	0.25	0.1	25
MMBZ5258BLT1	81J	34.20	36	37.80	3.4	70	700	0.25	0.1	27
MMBZ5259BLT1	81K	37.05	39	40.95	3.2	80	800	0.25	0.1	30
MMBZ5260BLT1	81L	40.85	43	45.15	3	93	900	0.25	0.1	33
MMBZ5261BLT1	81M	44.65	47	49.35	2.7	105	1000	0.25	0.1	36
MMBZ5262BLT1	81N	48.45	51	53.55	2.5	125	1100	0.25	0.1	39
MMBZ5263BLT1	81P	53.20	56	58.80	2.2	150	1300	0.25	0.1	43
MMBZ5264BLT1	81Q	57.00	60	63.00	2.1	170	1400	0.25	0.1	46
MMBZ5265BLT1	81R	58.90	62	65.10	2	185	1400	0.25	0.1	47
MMBZ5266BLT1	81S	64.60	68	71.40	1.8	230	1600	0.25	0.1	52
MMBZ5267BLT1	81T	71.25	75	78.75	1.7	270	1700	0.25	0.1	56
MMBZ5268BLT1	81U	77.90	82	86.10	1.5	330	2000	0.25	0.1	62
MMBZ5269BLT1	81V	82.65	87	91.35	1.4	370	2200	0.25	0.1	68
MMBZ5270BLT1	81W	86.45	91	95.55	1.4	400	2300	0.25	0.1	69

3. Zener voltage is measured with a pulse test current I_Z at an ambient temperature of 25°C

*Not Available in the 10,000/Tape & Reel.

MMBZ5221BLT1 Series

TYPICAL CHARACTERISTICS

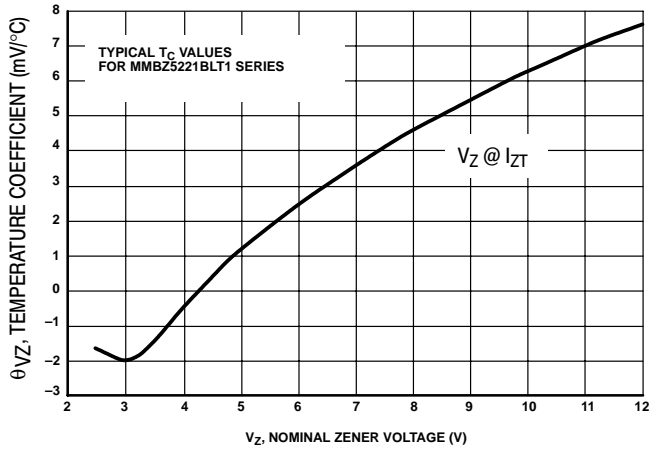

Figure 1. Temperature Coefficients
(Temperature Range -55°C to $+150^{\circ}\text{C}$)

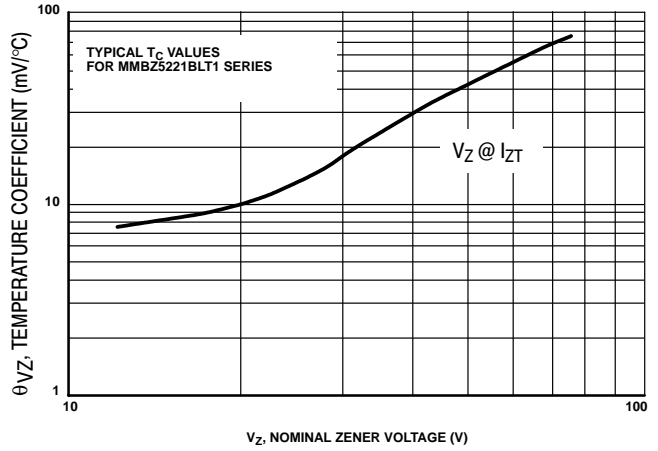

Figure 2. Temperature Coefficients
(Temperature Range -55°C to $+150^{\circ}\text{C}$)

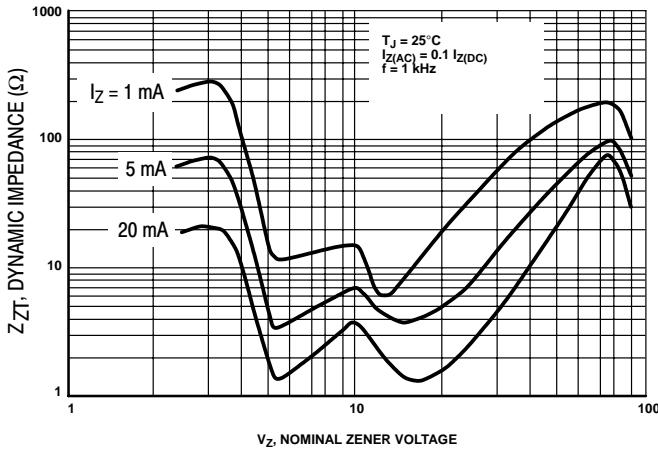

Figure 3. Effect of Zener Voltage on
Zener Impedance

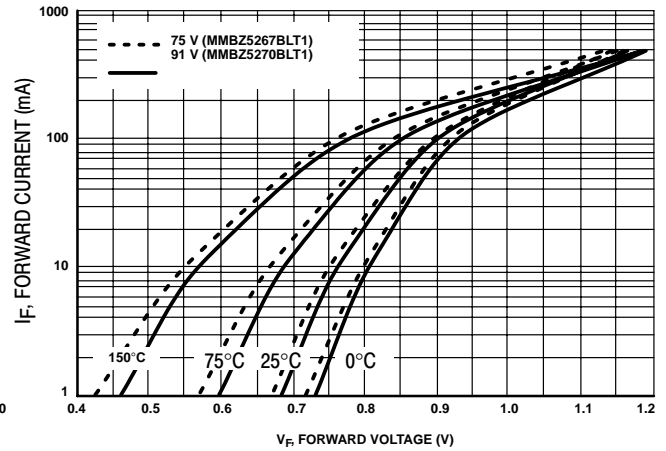

Figure 4. Typical Forward Voltage

MMBZ5221BLT1 Series

TYPICAL CHARACTERISTICS

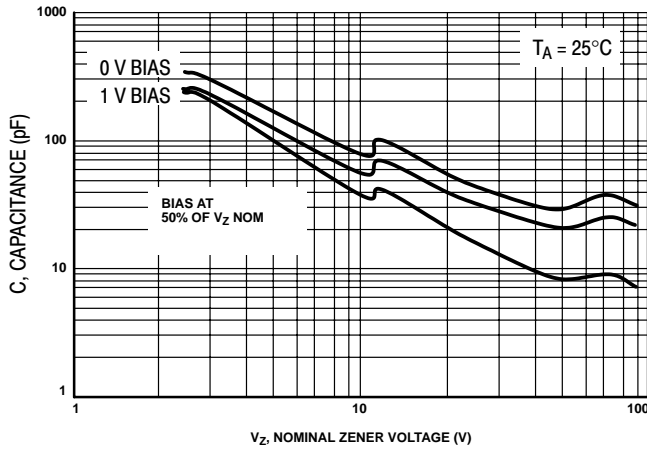

Figure 5. Typical Capacitance

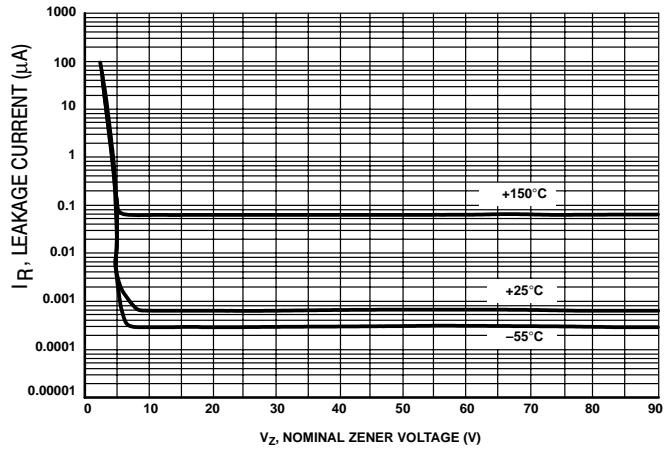

Figure 6. Typical Leakage Current

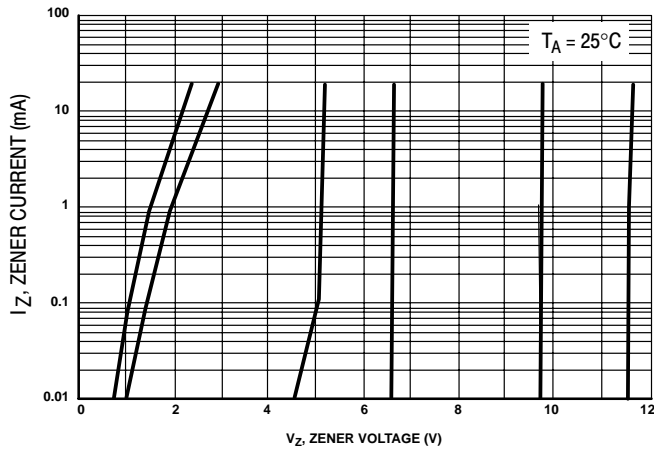

Figure 7. Zener Voltage versus Zener Current (V_Z Up to 12 V)

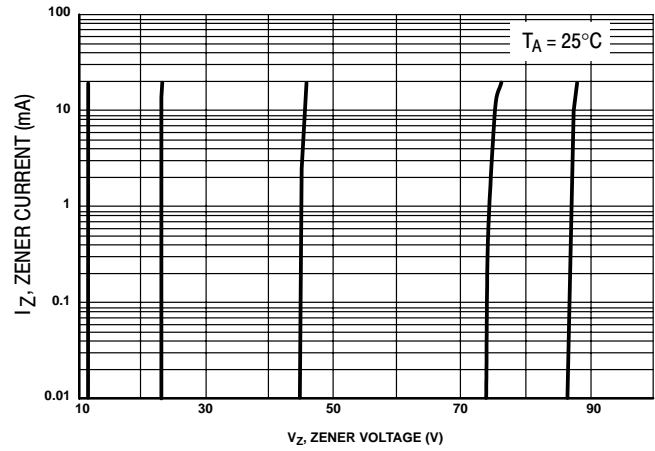
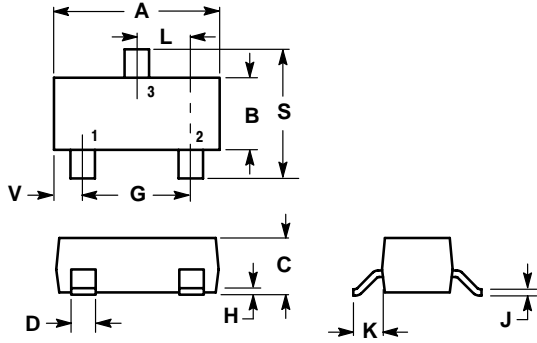

Figure 8. Zener Voltage versus Zener Current (12 V to 91 V)

MMBZ5221BLT1 Series

PACKAGE DIMENSIONS

SOT-23
TO-236AB
CASE 318-08
ISSUE AH



NOTES:

1. DIMENSIONING AND TOLERANCING PER ANSI Y14.5M, 1982.
2. CONTROLLING DIMENSION: INCH.
3. MAXIMUM LEAD THICKNESS INCLUDES LEAD FINISH THICKNESS. MINIMUM LEAD THICKNESS IS THE MINIMUM THICKNESS OF BASE MATERIAL.
4. 318-03 AND -07 OBSOLETE, NEW STANDARD 318-08.

DIM	INCHES		MILLIMETERS	
	MIN	MAX	MIN	MAX
A	0.1102	0.1197	2.80	3.04
B	0.0472	0.0551	1.20	1.40
C	0.0350	0.0440	0.89	1.11
D	0.0150	0.0200	0.37	0.50
G	0.0701	0.0807	1.78	2.04
H	0.0005	0.0040	0.013	0.100
J	0.0034	0.0070	0.085	0.177
K	0.0140	0.0285	0.35	0.69
L	0.0350	0.0401	0.89	1.02
S	0.0830	0.1039	2.10	2.64
V	0.0177	0.0236	0.45	0.60

Notes

MMBZ5221BLT1 Series

ON Semiconductor and  are registered trademarks of Semiconductor Components Industries, LLC (SCILLC). SCILLC reserves the right to make changes without further notice to any products herein. SCILLC makes no warranty, representation or guarantee regarding the suitability of its products for any particular purpose, nor does SCILLC assume any liability arising out of the application or use of any product or circuit, and specifically disclaims any and all liability, including without limitation special, consequential or incidental damages. "Typical" parameters which may be provided in SCILLC data sheets and/or specifications can and do vary in different applications and actual performance may vary over time. All operating parameters, including "Typicals" must be validated for each customer application by customer's technical experts. SCILLC does not convey any license under its patent rights nor the rights of others. SCILLC products are not designed, intended, or authorized for use as components in systems intended for surgical implant into the body, or other applications intended to support or sustain life, or for any other application in which the failure of the SCILLC product could create a situation where personal injury or death may occur. Should Buyer purchase or use SCILLC products for any such unintended or unauthorized application, Buyer shall indemnify and hold SCILLC and its officers, employees, subsidiaries, affiliates, and distributors harmless against all claims, costs, damages, and expenses, and reasonable attorney fees arising out of, directly or indirectly, any claim of personal injury or death associated with such unintended or unauthorized use, even if such claim alleges that SCILLC was negligent regarding the design or manufacture of the part. SCILLC is an Equal Opportunity/Affirmative Action Employer.

PUBLICATION ORDERING INFORMATION

Literature Fulfillment:

Literature Distribution Center for ON Semiconductor
P.O. Box 5163, Denver, Colorado 80217 USA
Phone: 303-675-2175 or 800-344-3860 Toll Free USA/Canada
Fax: 303-675-2176 or 800-344-3867 Toll Free USA/Canada
Email: ONlit@hibbertco.com

N. American Technical Support: 800-282-9855 Toll Free USA/Canada

JAPAN: ON Semiconductor, Japan Customer Focus Center
4-32-1 Nishi-Gotanda, Shinagawa-ku, Tokyo, Japan 141-0031
Phone: 81-3-5740-2700
Email: r14525@onsemi.com

ON Semiconductor Website: <http://onsemi.com>

For additional information, please contact your local
Sales Representative.